

6060 - (MOTORIZED SELVEDGE RH & LH)

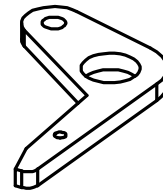

● 6061 R
B 163175
BA 306528

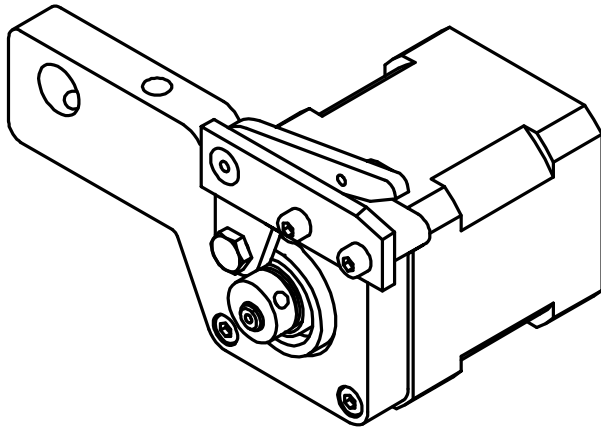
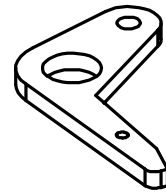

● 6061 L
BE 306529

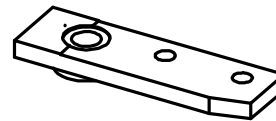

● 6062 R
BE 207668
BE 306532

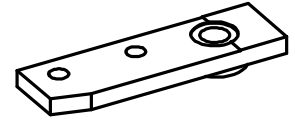

● 6062 L
BE 306533

6060A-0R CUTTER ASSEMBLY W/O MOTOR

6060A-00R CUTTER ASSEMBLY WITH
R > BE 235169 STEPPER MOTOR RH

6060A-0L CUTTER ASSEMBLY W/O MOTOR

6060A-00L CUTTER ASSEMBLY WITH
STEPPER MOTOR RH

6070 - (TUCK IN SELVEDGE)



● 6071
B 158983

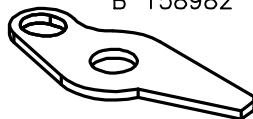

● 6072
B 158982

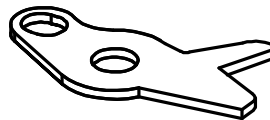

● 6073
B 96950

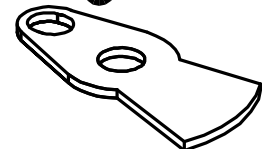

● 6074

MATERIAL CODE : ● SOLID CARBIDE , ○ HSS , ◐ BRAZED CARBIDE , ⊙ TIN COATED